

1 of three cover plates to sit flush. 350 dia 4 screws into plate below

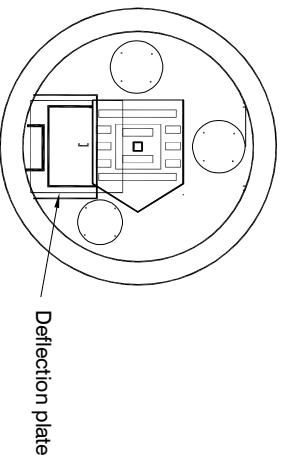

View of deflection plate

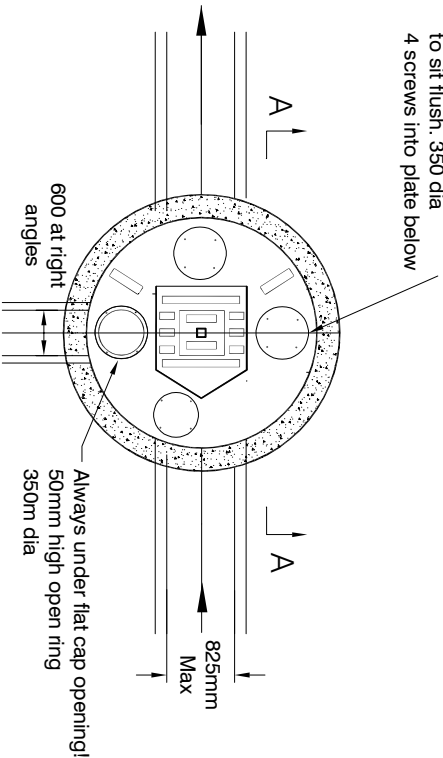
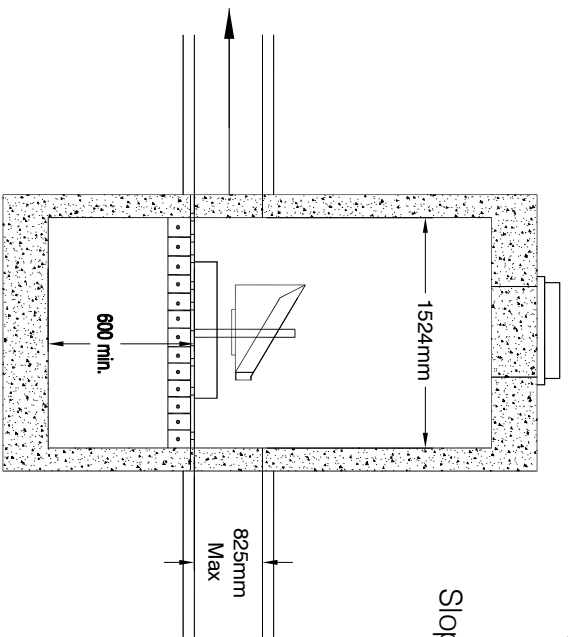

Section A-A

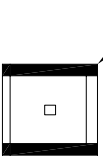

Flexible rubber on sides

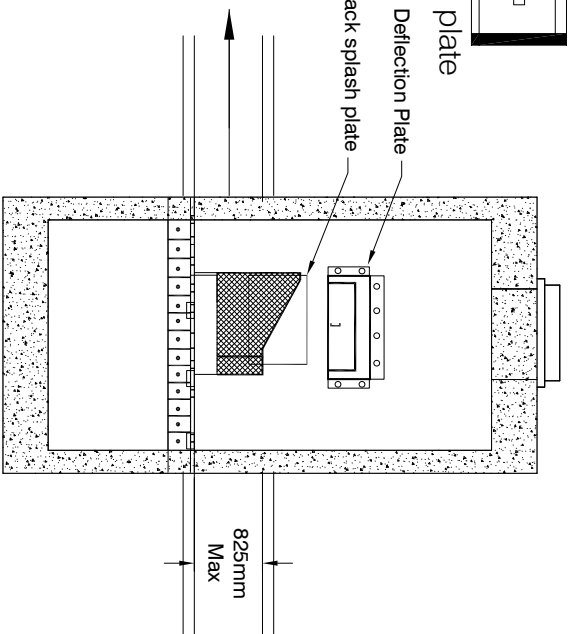

Inlet deflection wall

To be attached during installation
Location is opposite of deflection plate

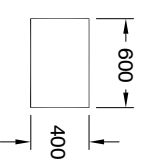

Back splash plate

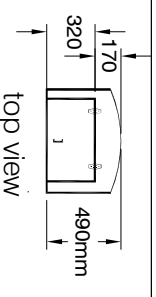

top view

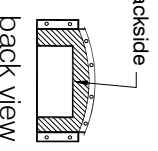

back view

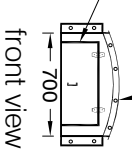

front view



side view

Deflection plate details



CBMH Shield-1500mm Shop dwg (centre insert)